

ROBERTS

Sound for Generations



CD9912

Stereo CD Radio
Cassette Recorder

Please read this manual before use

<i>Contents</i>	1
<i>Controls</i>	2-3
<i>Display</i>	4
<i>Battery Operation</i>	5
<i>Mains Operation</i>	5
<i>General</i>	6
<i>Sound controls</i>	6
<i>Radio operation</i>	7
<i>Presetting stations</i>	8
<i>Recalling a preset station</i>	9
<i>Last station memory</i>	9
<i>Compact discs</i>	10
<i>Inserting a CD</i>	10
<i>Playing a CD</i>	11
<i>Selecting a track</i>	12
<i>Random play</i>	12
<i>Intro play</i>	12
<i>Repeat play</i>	13
<i>CD programmed play</i>	13
<i>Checking a programme</i>	14
<i>Changing a programme</i>	14
<i>Playing a programme</i>	15
<i>Erasing a programme</i>	15

<i>Listening to cassette tapes</i>	16
<i>Recording from the radio</i>	17
<i>Recording from CD</i>	17
<i>Preventing accidental erasure</i>	18
<i>Cleaning tape heads</i>	18
<i>Remote control</i>	19
<i>Headphones</i>	20
<i>Specification</i>	21
<i>Guarantee</i>	22



Warning

CLASS 1 LASER PRODUCT means that the laser's construction makes it inherently safe so that the legally prescribed maximum permissible radiation values can never be exceeded

Caution: Using any equipment or devices other than those described and specified in these operating instructions, or tampering with the unit in any way, can result in dangerous exposure to radiation.

Controls (Top)

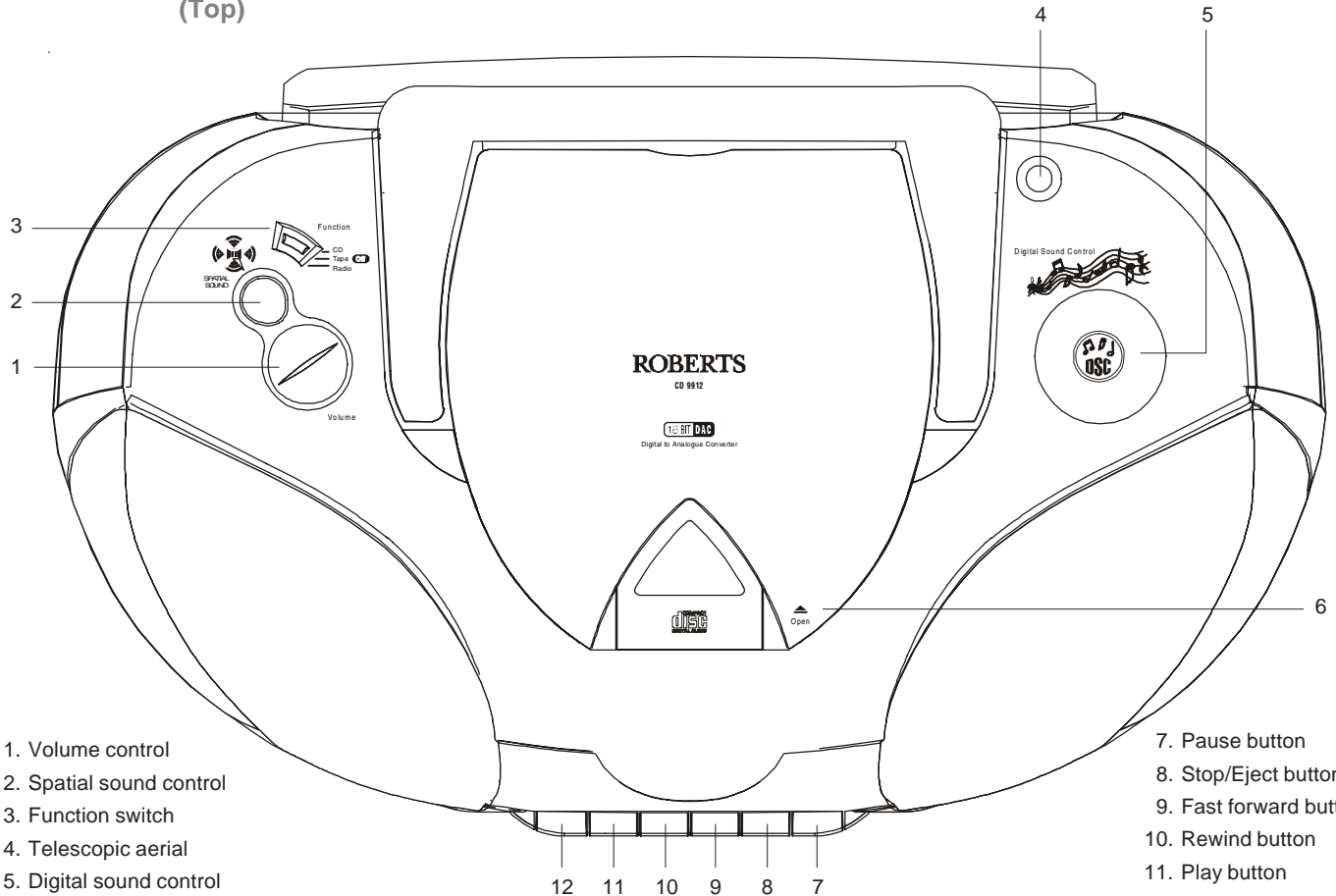

- 1. Volume control
- 2. Spatial sound control
- 3. Function switch
- 4. Telescopic aerial
- 5. Digital sound control
- 6. CD door

- 7. Pause button
- 8. Stop/Eject button
- 9. Fast forward button
- 10. Rewind button
- 11. Play button
- 12. Record button

If you need any further advice, please call our Technical Helpline on :-
020 8758 0338 (Mon-Fri)

Controls

(Front)

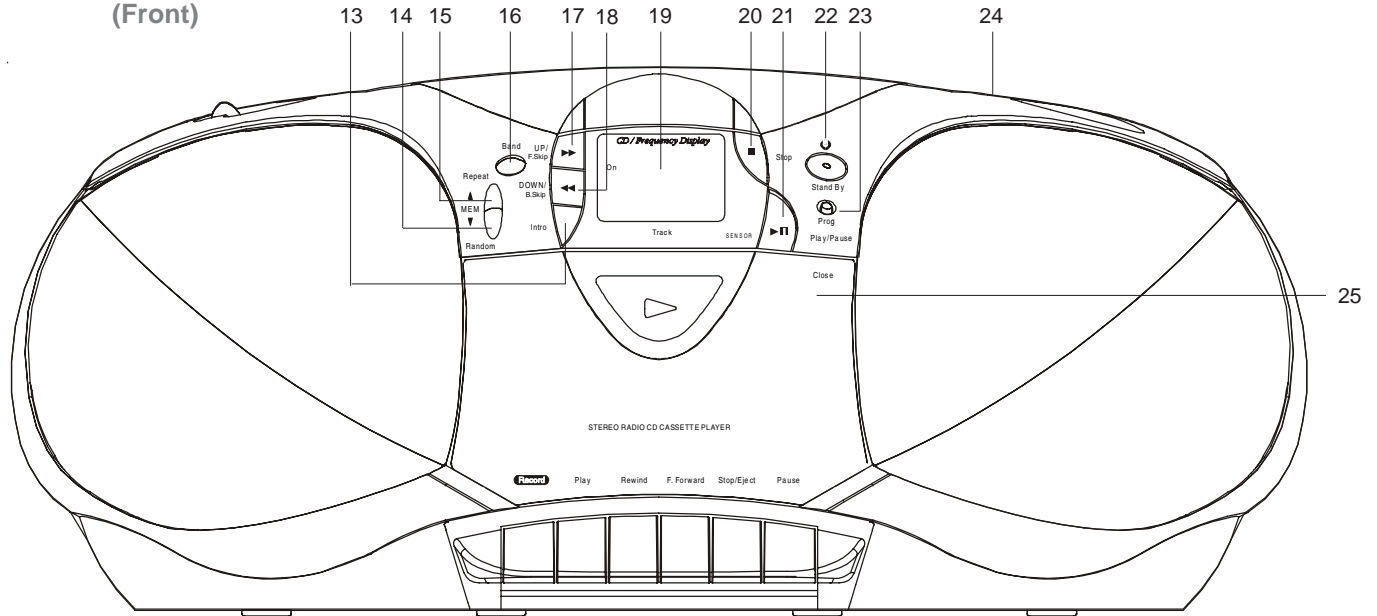

- 13. Intro button
- 14. Random/Memory down button
- 15. Repeat/Memory up button
- 16. Band select button
- 17. Tuning Up/F.Skip button
- 18. Tuning Down/B.Skip button
- 19. Display

- 20. Stop button
- 21. Play/pause button
- 22. Standby button
- 23. Prog. button
- 24. FM Mono/Stereo switch (on rear)
- 25. Cassette door

Display

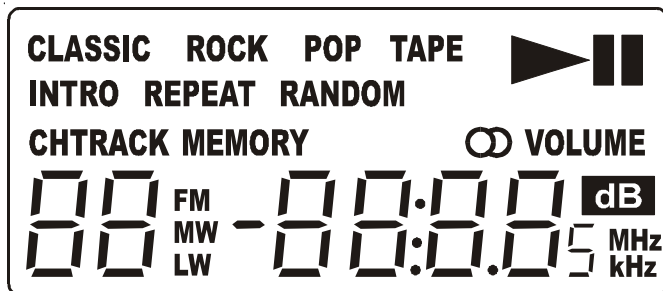

CLASSIC, ROCK, POP

Indicates sound effect



Lights during CD playback



Lights during CD pause

INTRO

Lights during CD intro mode

REPEAT

Lights during CD repeat all tracks
Flashes during CD repeat one track

RANDOM

Lights during CD random play

CH

Indicates radio memory channel

TRACK

Indicates CD track



Lights when receiving FM stereo stations

VOLUME

Lights when adjusting volume

FM/MW/LW

Indicates selected waveband



Indicates CD track number or radio memory channel



Indicates CD playing time or radio station frequency

MHz/kHz

Shows MHz for FM reception and kHz for MW/LW reception

Battery operation

1. Remove the **Battery cover** on the rear of your CD radio cassette by pushing the catches in the direction of the arrows.
2. Insert two LR6 (AA size) batteries into the small spaces in the battery compartment. Insert eight LR20 (D size) batteries into the remaining spaces in the compartment. Take care to ensure all batteries are inserted with the correct polarity as shown inside the battery compartment. Replace the battery cover.

note : the two LR6 batteries provide power for the radio memory and must be fitted at all times.

3. Reduced power, distortion, and a 'stuttering' sound are all signs that the batteries may need replacing. If your CD radio cassette is not to be used for any extended period of time it is recommended that the eight LR20 (D size) batteries are removed from the radio.

We would recommend for economy that the CD9912 is used on the mains whenever possible with battery operation for occasional or stand-by use only.

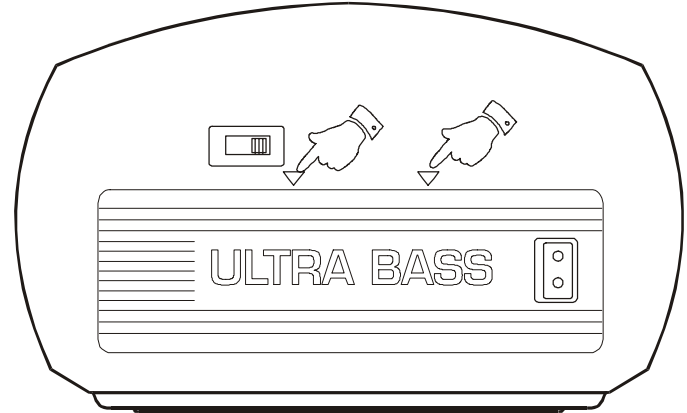

Mains operation

1. Place your CD radio cassette on a flat surface.
2. Plug the mains lead into the **Socket** located on the rear of your CD radio cassette. Ensure that the plug is pushed fully into the socket.
3. Plug the other end into a wall socket and switch on.
4. Do not allow this unit to be exposed to water, steam or sand. Do not leave your radio where excessive heat could cause damage such as in a parked car where the heat from the sun can build up even though the outside temperature may not seem too high.

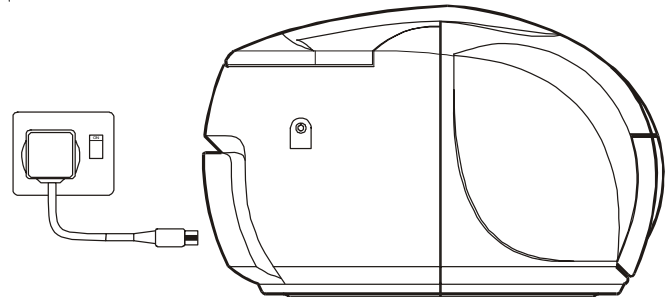

General

Switching on and off

1. Press the **Standby button** to switch on. The **Standby indicator** located within the Standby button will turn off.
2. To switch off press the **Standby button** again. The **Standby indicator** will light up.
3. When using the mains supply the **Standby button** on the remote control can be used to turn the unit on and off.
4. When using battery supply the **Standby button** on the remote control can only be used to turn the unit off. This is to save battery life.

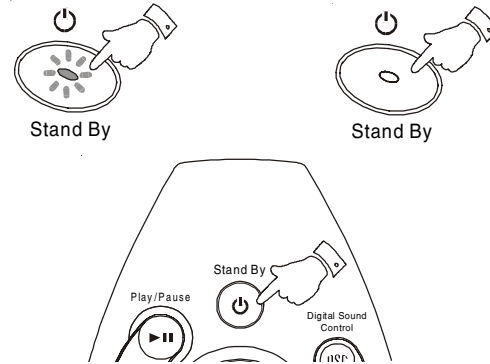

Sound controls

Volume

1. Adjust the volume to the required level using the **Volume control**.

Spatial sound

1. This feature creates a 3-D effect from the stereo sound produced by the loudspeakers. Press the **Spatial sound** button to turn on Spatial sound. Press the button again to release and turn off Spatial sound.

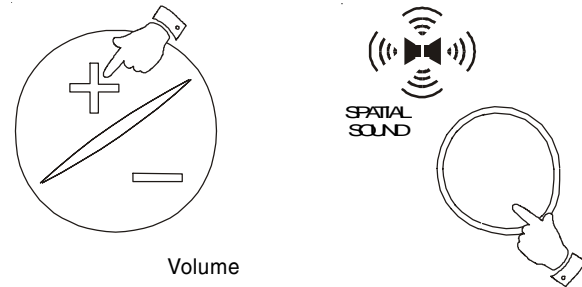

Digital Sound Control (DSC)

The DSC feature creates a realistic atmosphere for a style of music using the latest digital sound technology.

1. Repeatedly press and release the DSC button until the desired sound effect **CLASSIC**, **ROCK** or **POP** is shown on the display.



Radio operation

note : the two LR6 batteries provide power for the radio memory and must be fitted at all times.

1. Set the **Function switch** to the 'Radio' position.
2. Adjust the **Volume control** until a hissing sound is heard.
3. Repeatedly press and release the **Band button** until the required waveband appears in the display. On FM fully extend the **Telescopic aerial**. On MW and LW rotate your radio for best reception.
4. Press and hold down either the **UP ►►** or **DOWN ◄◄** buttons until the frequency in the display begins to change rapidly. Release the button.
5. Your radio will scan the selected waveband, stopping each time it finds a station of sufficient strength. Adjust the **Volume control** to the required level.
6. To search for additional stations repeat the above procedure. Search tuning may be stopped by a single press on either the **UP ►►** or **DOWN ◄◄** buttons.
7. To tune to a weak station repeatedly press and release the **UP ►►** or **DOWN ◄◄** buttons until the correct frequency is displayed or until reception is best.
8. On FM if the station being received is weak some hiss may be audible, to reduce the hiss set the **FM mode switch** (located on the rear of the unit) to the 'Mono' position.

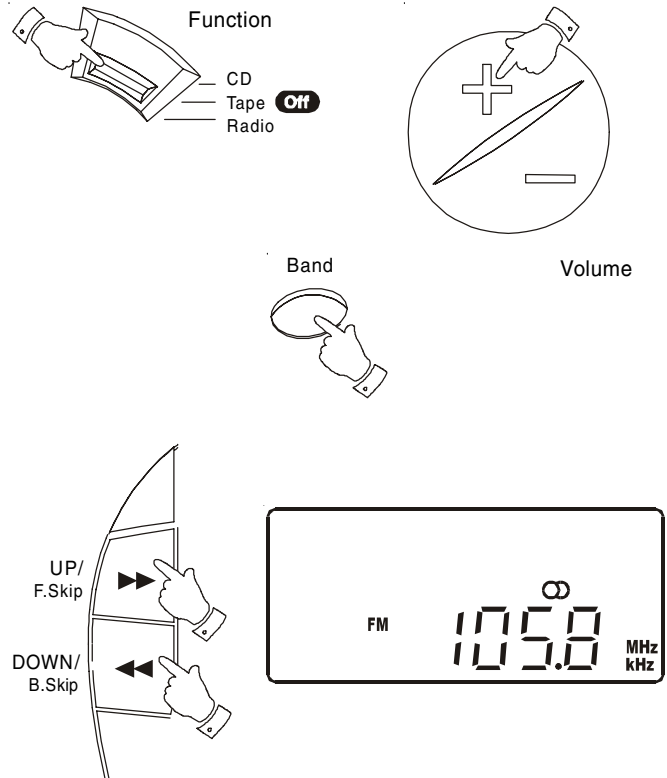

Presetting stations

You may store up to 40 different stations, 20 on FM, 10 on MW and 10 on LW.

1. Select the required waveband using the **Band button**.
2. Select the required station using the **UP ►►** or **DOWN ◄◄** buttons.
3. Press the **Prog. button**. **MEMORY** will flash in the display.
4. Select the required memory channel where you wish to store the station using the **MEM ▲** or **▼** buttons.
5. Whilst **MEMORY** is flashing in the display press **PROG.** to store the station.
6. Memory will disappear from the display. The display will indicate the stations memory channel, its frequency and waveband.
7. Repeat the above procedure for the remaining presets.
8. If you assign a station to a memory channel that had been previously assigned to a different station the old station is deleted and replaced by the new one.

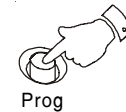
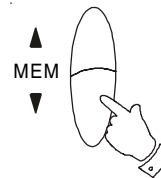
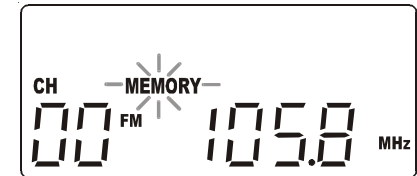
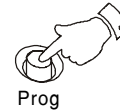
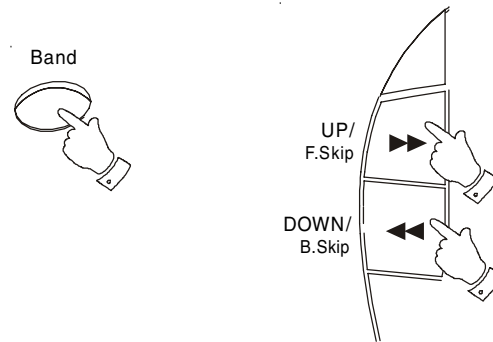

Recalling a preset station

1. Select the required waveband using the **Band button**.
2. Select the desired memory channel using the **MEM ▲** or **▼ buttons**. The display indicates the selected channel, station frequency and waveband.

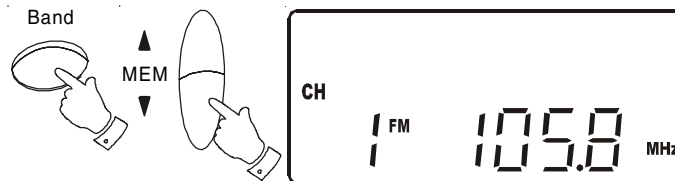

Last station memory

1. Your radio provides an automatic last station memory function. This function recalls the station that was playing when the radio was switched off.

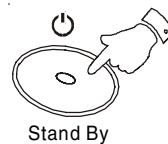

Compact discs

Use only Digital Audio CDs which have the



symbol.

Never write on a CD or attach any sticker to the CD. Always hold the CD at the edge and store it in its box after use with the label facing up.

To remove dust and dirt, breathe on the CD and wipe it with a soft, lint-free cloth in a straight line from the centre towards the edge.

Cleaning agents may damage the CD

Do not expose the CD to rain, moisture, sand, or to excessive heat. (e.g. from heating equipment or in motor cars parked in the sun).

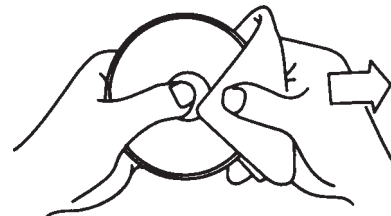

Inserting a CD

1. Set the **Function switch** to CD.
2. To open the CD compartment, push the **CD door** on the edge marked 'Open'.
3. Insert an Audio CD, printed side facing up. Close the CD door. The CD player will scan the contents of the CD and the total number of tracks will appear on the display.

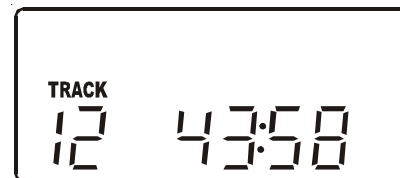
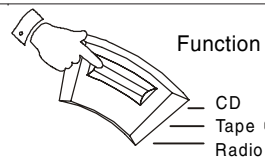

Playing a CD

1. Press the **Play/Pause button** to start playback.
2. Set the **Volume** to the required level.
3. Set the **Spatial sound** and **DSC controls** to the required positions.
4. To pause playback press the **Play/Pause button**. The **Pause symbol** will appear in the display. To resume playback press the **Play/Pause button** again.
5. To stop playback, press the **Stop button**. The total number of CD tracks and playing time will appear on the display.
6. To take out the CD, open the CD door by pushing the edge marked 'Open'. The CD door should only be opened when the CD is in Stop mode.

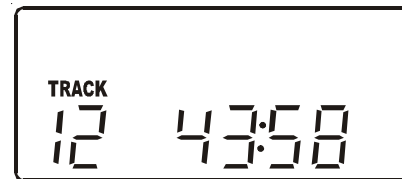
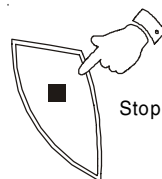
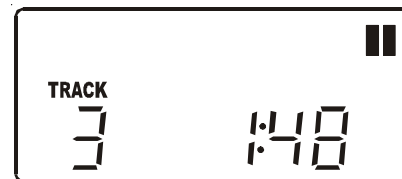
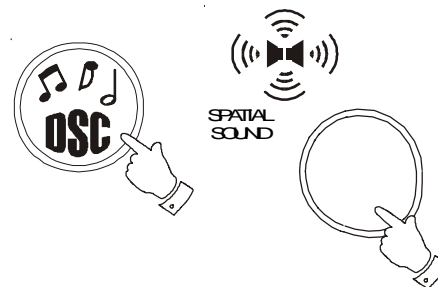
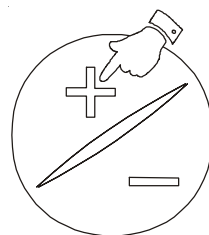

Selecting a track

1. Whilst the CD is playing, press either the **B.skip** ◀◀ or **F.skip** ▶▶ **buttons** to change to the desired track.
2. You can also skip tracks when the player is in stop mode. Skip to the desired track using the **B.skip** ◀◀ or **F.skip** ▶▶ **buttons**. Press the **Play/Pause button** to play the selected track.
3. You can search for a particular part of a track whilst the CD is playing, press and hold down either the **B.skip** ◀◀ or **F.skip** ▶▶ **buttons**. Release the button when the desired part of the track is reached.

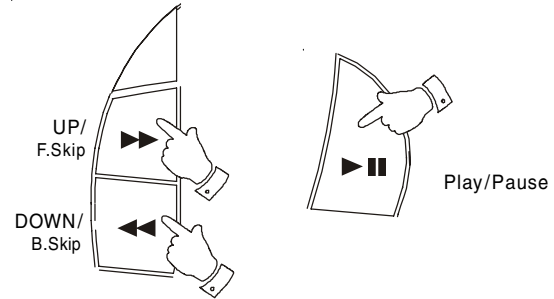

Random play

1. Press the **Random button**. 'RANDOM' will appear in the display.
2. Press the **Play/Pause button**, tracks are played in random order until all tracks have been played once.
3. Press the **Stop button** to cancel Random play.
4. Random play is not possible during playback of a CD programme.

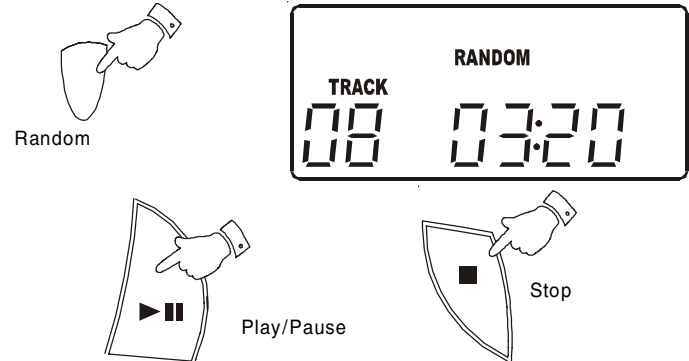

Intro play

1. Press the **Intro button**. 'INTRO' will appear in the display.
2. The first 10 seconds of each CD track will play.
3. Press the **Stop button** to cancel Intro play

If you need any further advice, please call our Technical Helpline on :-
020 8758 0338 (Mon-Fri)



Repeat play

Repeating the CD

1. Press the **Repeat button** once. 'REPEAT' will appear in the display.
2. Press the **Play/Pause button**, the CD will repeat continuously.
3. Press the **Stop button** to cancel repeat play.

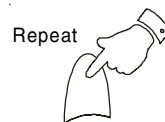

Repeating a track

1. Press the **Repeat button** twice. 'REPEAT' will flash in the display.
2. Press the **Play/Pause button**, the track will repeat continuously.
3. Press the **Stop button** to cancel repeat play.



CD programmed play

By programming your CD player you can play up to 20 tracks in any desired order.

1. Whilst the CD is in STOP mode, press the **Prog. button**. 'MEMORY' and 'TRACK' will flash in the display.
2. Select the first track using the **B.skip** ◀◀ or **F.skip** ▶▶ buttons.
3. Press the **Programme button** to store the track.
4. Repeat the above steps until you have completed your program. Press the **Play/Pause** button to commence play of the selected tracks.

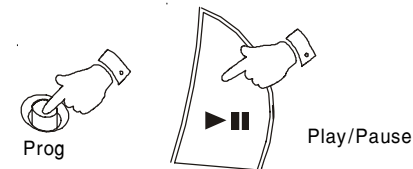
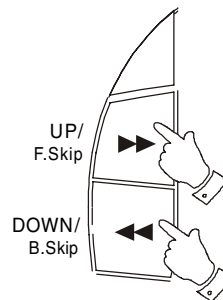
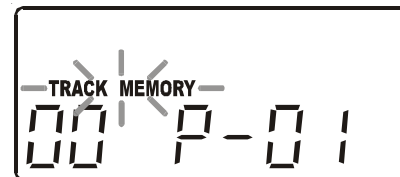
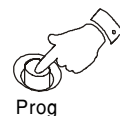

Checking a programme

1. Whilst the CD is in STOP mode, repeatedly press and release the **Prog. button** to step through the programme. The display will show the programme and track numbers.
2. Press the **Play/Pause** button to commence playback of the programme.

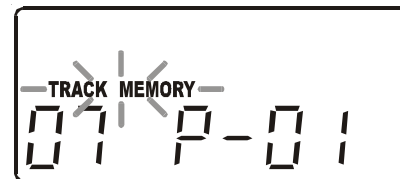
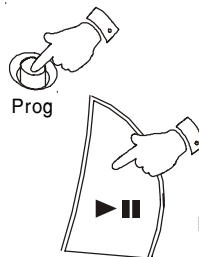

Changing a programme

Adding tracks to the programme

1. Repeatedly press and release the **Prog. button** until the display shows the first empty memory location (00 under track).
2. You can now add track to the programme as described earlier (max 20 tracks).

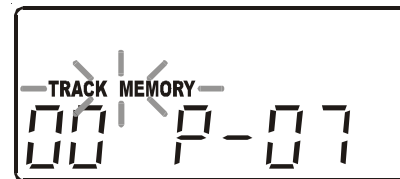
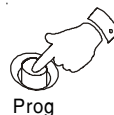

Replacing previously programmed tracks

1. Repeatedly press and release the **Prog. button** until the display shows the memory location you wish to replace.
2. Select the new track using the **B.skip** ◀◀ or **F.skip** ▶▶ buttons.
3. Store the track by pressing the **Prog. button**.
4. Press the **Play/Pause** button to commence playback of the programme.

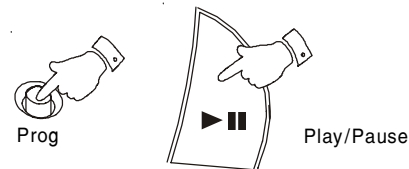
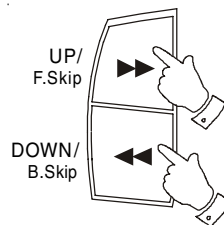
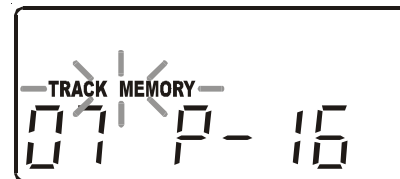

Playing a programme

1. Press the **Prog. button** once to show the first track of the programme.
2. Press the **Play/pause button**. Play will start with the first track of the programme and stop after the last track of the programme.
3. Press the **Stop button** to stop playback of a programme.
4. Whilst playing a programme it is possible to select the required programme track using the **B.skip** ◀◀ or **F.skip** ▶▶ buttons.

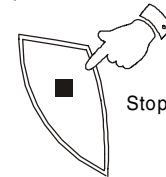
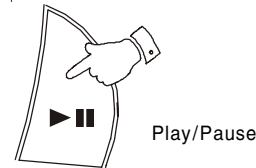
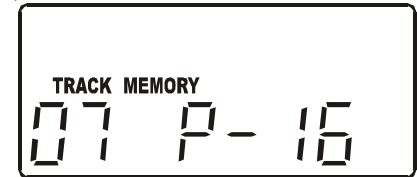
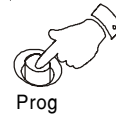

Erasing a programme

1. To clear a CD programme press the **Prog. button** followed by the **Stop button**.
2. CD programmes can only be erased whilst the CD player is in stop mode.
3. CD programmes are also erased:-
By opening the CD door
Moving the function switch from the CD position
If the batteries are exhausted or if the power supply is interrupted in any way.

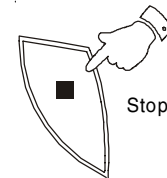

Listening to cassette tapes

Note: This unit is not suitable for recording onto CHROME (IEC II) or METAL (IEC IV) cassettes. For playback any cassette type may be used

1. Set the **Function switch** to the 'Tape' position.
2. Press the **Stop eject button** to open the **Cassette compartment**.
3. Insert a pre-recorded cassette with the tape surface downwards and the side with the desired recording facing towards you.
4. Close the **Cassette compartment**.
5. Depress the **Play button** and adjust the **Volume control** to suit your personal taste.
6. Set the **Spatial sound** and **DSC controls** to the required positions
7. Use the **Fast forward** or **Rewind buttons** to locate a specific part of the tape.
8. If you wish to temporarily stop the playback depress the **Pause button**. When you are ready to resume playback press the **Pause button** a second time.
9. To stop the tape press the **Stop/Eject button**.

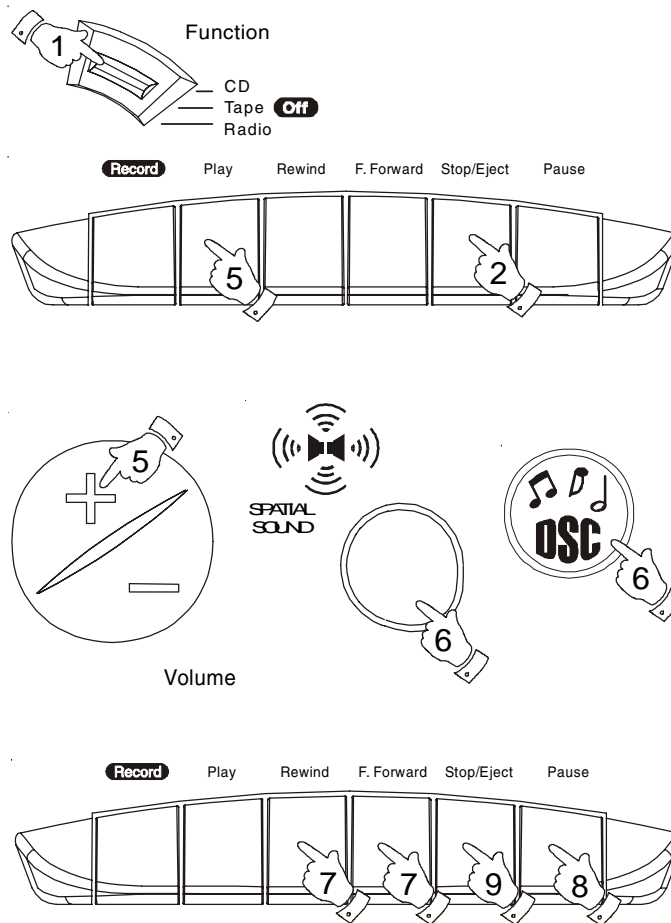

Recording from the Radio

1. Set the **Function switch** to the 'Radio' position.
2. Tune in to the desired station.
3. Adjust the **Volume control** to suit your requirements.
4. Insert a blank cassette with the tape surface downwards and the side you wish to record on facing towards you.
5. Depress the **Record button** to commence recording.
6. The recording level is set automatically and is not affected by the setting of the **Volume control**.
7. To stop the recording press the **Stop/Eject button**.

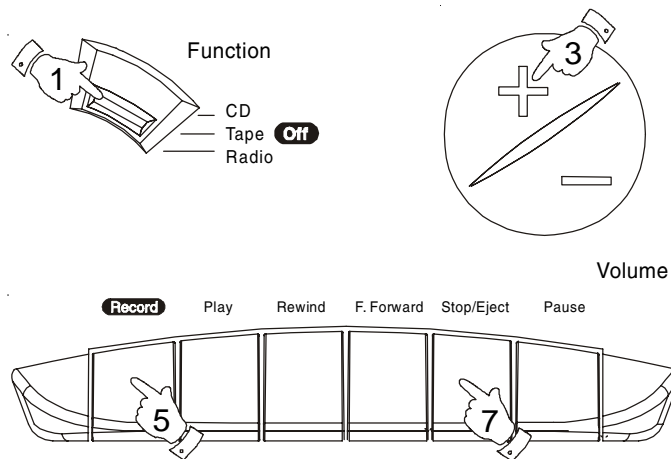

Recording from CD

1. Set the **Function switch** to the 'CD' position.
2. Insert a CD into the compartment. Insert a blank cassette with the tape surface downwards and the side you wish to record on facing towards you.
3. Depress the **Record button** to commence recording. The CD will start automatically (CD syncro start)
4. To stop the recording press the **Stop/Eject button**.

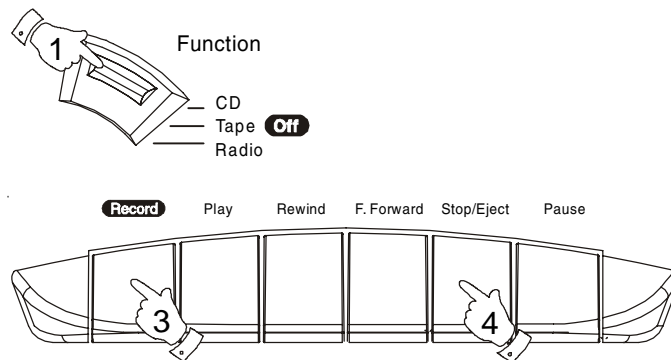

Preventing accidental erasure

1. To safeguard your recordings against accidental erasure, break off the appropriate tab on the cassette as shown .
2. There is one tab for each side of the cassette. This will prevent the Record button from being pressed.
3. To restore the cassette to normal, seal the tab openings with a small piece of self-adhesive tape.

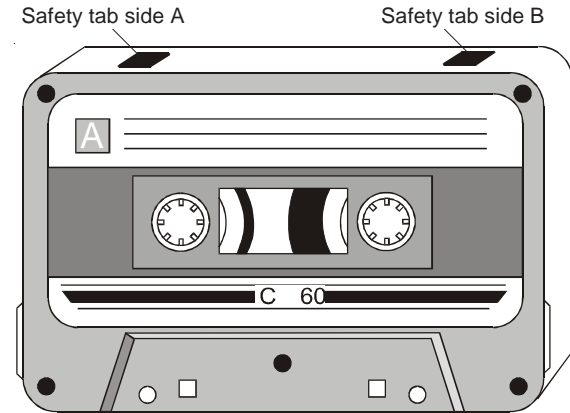

Cleaning tape heads

The oxide from magnetic tapes can accumulate on the pinch roller (A) the capstan shaft (B) and also the heads (C and D). This will impair the sound quality.

To clean these parts proceed as follows:-

1. Turn off the power to the unit.
2. Press the **Stop/Eject button**.
3. Press the **Play button** and the heads will be clearly seen.
4. Clean the surfaces (A, B, C, D) with a lint free rag or cotton swab soaked in alcohol. Press the stop/eject button as soon as cleaning is over.

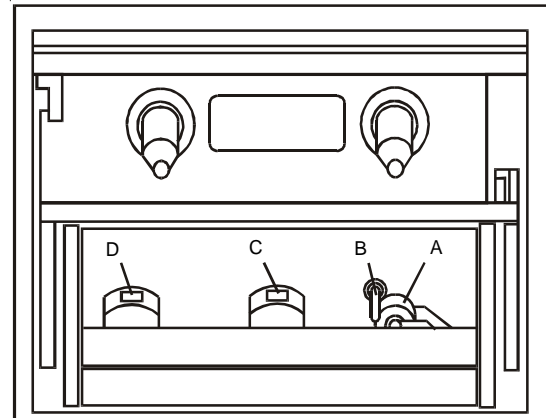

Remote control

The buttons on the remote control have the same functions as the corresponding buttons on the main unit.

Note: When using your CD radio cassette on batteries, the Standby button on the remote handset can only be used to switch the unit off. To switch the unit on when using battery supply, use the Standby button on the main unit.

Batteries

1. Open the compartment on the rear of your remote control by sliding the cover in the direction of the arrow.
2. Insert two LR03 (AAA size) batteries into the small spaces in the battery compartment. Take care to ensure the batteries are inserted with the correct polarity as shown inside the battery compartment. Replace the battery cover.

Replacement of batteries

1. If the range of your infrared remote control seems to decrease, or if certain functions no longer operate, you should replace the batteries.
2. If your remote control is not to be used for any extended period of time it is recommended that the two LR03 batteries are removed from the handset.

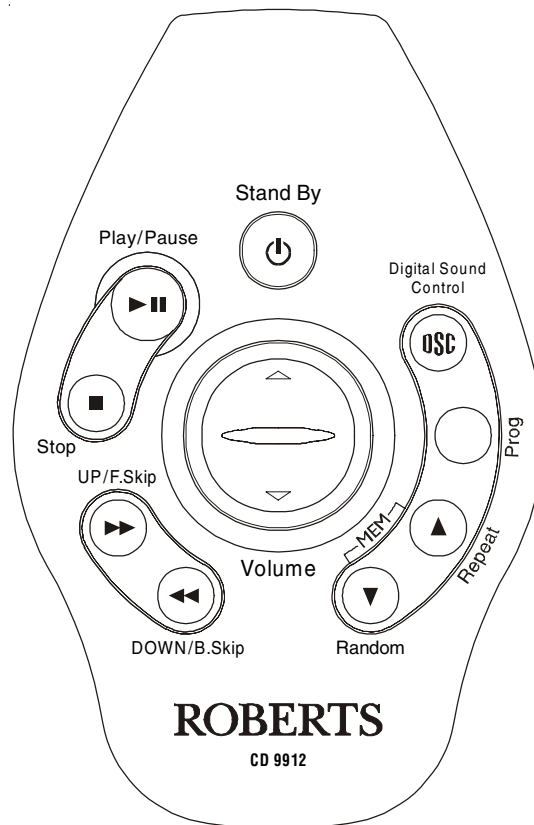

Headphones

1. A **Headphone Socket** (3.5mm) located on the left hand end of your CD radio cassette is provided for use with either headphones or an earpiece. Inserting the headphone plug automatically mutes the internal loudspeaker.

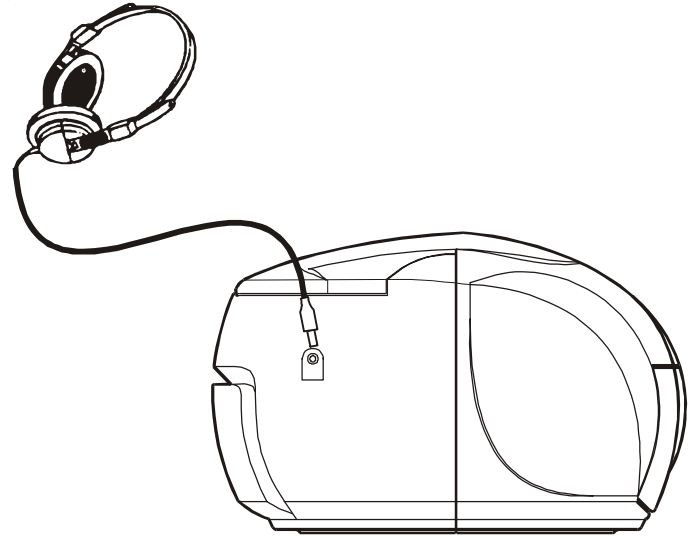

Specifications

Power Requirements

Mains	AC 230 volts, 50Hz  only
Batteries	8 x LR20 (C size) 2 x LR6 (AA size) 2 x LR03 (AAA size) included

Frequency Coverage

FM	87.5-108MHz
MW	522- 1620kHz
LW	146- 281kHz

Circuit Features

Loudspeaker	2 x 100mm
Output Power	2 x 2.5 Watts
Headphone socket	3.5mm dia
Aerial System	FM Telescopic aerial MW Built-in Ferrite aerial LW Built-in Ferrite aerial

ROBERTS RADIO LIMITED

PO BOX 130
MEXBOROUGH
SOUTH YORKSHIRE
S64 8YT

The Company reserves the right to amend the specification without notice.

Guarantee

This instrument is guaranteed for twelve months from the date of delivery to the original owner against failure due to faulty workmanship or component breakdown, subject to the procedure stated below. Should any component or part fail during this guarantee period it will be repaired or replaced free of charge.

The guarantee does not cover:

1. Damage resulting from incorrect use.
2. Consequential damage.
3. Receivers with removed or defaced serial numbers.

N.B. Damaged or broken telescopic aerials will not be replaced under guarantee.

Procedure:

Any claim under this guarantee should be made through the dealer from whom the instrument was purchased. It is likely that your Roberts' dealer will be able to attend to any defect quickly and efficiently, but should it be necessary the dealer will return the instrument to the company's service department for attention. In the event that it is not possible to return the instrument to the Roberts' dealer from whom it was purchased, please contact Roberts

Radio Technical Services department at the address shown on the rear of this booklet before taking further action.

These statements do not affect the statutory rights of a consumer.

ROBERTS RADIO TECHNICAL SERVICES DEPARTMENT

97-99 Worton Road
Isleworth Middlesex
TW7 6EG

Technical Helpline:- 020 8758 0338 (*Mon-Fri*)

Issue 1

